

Chapitre N

FIXTATEURS EXTERNES
EXTERNAL FIXATORS

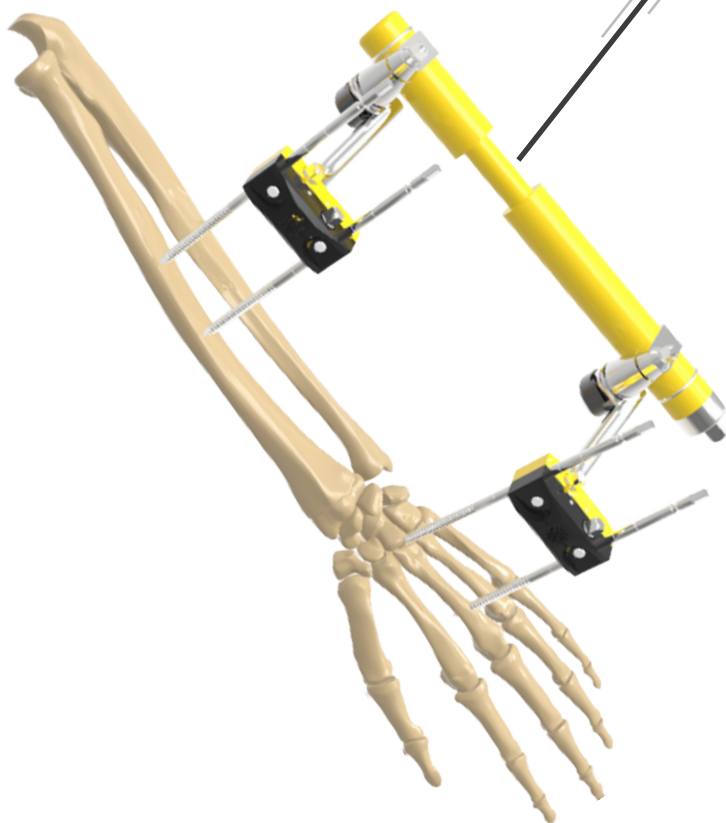

1 FIXATEURS EXTERNES LATERAL NHI
LATERAL EXTERNAL FIXATORS NH I

**Etau à rotule universel
Universal joint clamp**



Taille / Size	Code
Grand / Large	201002
Petit / Small	201012

**Etau à rotule universel double
Double universal joint clamp**



Taille / Size	Code
Grand / Large	201022
Petit / Small	201032

**Etau à rotule universel avec tige
Universal joint clamp with rod**



Taille / Size	Code
Grand / Large	201042
Petit / Small	201052

1 FIXATEURS EXTERNES LATERAL NHI
LATERAL EXTERNAL FIXATORS NH I

Rotule à tige
Ball joint with rod



Taille / Size	Code
Grand / Large	201082
Petit / Small	201092

Couplage d'articulation
Articulation coupling



Taille / Size (mm)	Code SS
8/8	201101
8/5	201102
5/5	201103
5/3	201104
5/4	201105
8/4	201106
8/3	201107

Etau à tige
Clamp with rod



Taille / Size	Code SS
Grand / Large	201122
Petit / Small	201132

1 FIXATEURS EXTERNES LATERAL NHI
LATERAL EXTERNAL FIXATORS NH I

**Etau à tige double
Clamp with 2 rods**



Taille / Size	Code SS
Grand / Large	201142
Petit / Small	201152

**Pivot d'union à trous parallèles
Swivelling coupling with parallel holes**



Taille / Size	Code SS
Grand / Large	201161
Petit / Small	201171

**Pivot d'union à trous orthogonaux
Swivelling coupling with orthogonal holes**



Taille / Size	Code SS
Grand / Large	201181
Petit / Small	201191

1 FIXATEURS EXTERNES LATERAL NHI
LATERAL EXTERNAL FIXATORS NH I

Barre d'union droite
Straight connecting rod



Ø (mm)	Longueur/Length (mm)	Code SS
5	100	201201
	150	201202
	200	201203
	250	201204
	300	201205
8	100	201221
	150	201222
	200	201223
	250	201224
	300	201225

barre de connexion ajustable Ø8 mm
Adjustable connecting rod Ø8 mm

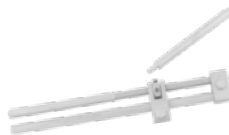

Longueur/Length (mm)	Code SS
100/100	201231
150/150	201232
200/200	201233
250/250	201234

1 FIXATEURS EXTERNES LATERAL NHI
LATERAL EXTERNAL FIXATORS NHI

Barre de connexion ajustable Ø5 mm
Adjustable connecting rod Ø5 mm



Longueur/Length (mm)	Code SS
100	201241
150	201242
200	201243
250	201244

Barre d'union coudée
Cranked connecting rod



Taille / Size	Code SS
Grand / Large	201261
Petit / Small	201271

Etau à rotule parallèle
Universal joint clamp



Taille / Size	Code SS
Grand / Large	201302
Petit / Small	201312

1 FIXATEURS EXTERNES LATERAL NHI
LATERAL EXTERNAL FIXATORS NH I

Etau à rotule parallèle double
Double universal joint clamp



Taille / Size	Code
Grand / Large	201322
Petit / Small	201332

Demi-fiche à os cortical, perforante, auto taraudante
Self drilling tapping cortical bone pin



Ø (mm)	Longueur/Length (mm)	Long. filetée / Threaded length (mm)	Code SS
3	60	15	307141
	80	20	307142
	110	25	307143
	120	40	307041
4	150	40	307042
	150	45	307043
	180	50	307044
	200	50	307045
5	120	50	307241
	150	50	307242
	180	50	307243
	200	60	307244

1 FIXATEURS EXTERNES LATERAL NHI
LATERAL EXTERNAL FIXATORS NH I

Fiche transfixiante à filetage central
Transfixing pin with central thread



Ø Fiche / Ø Pin (mm)	Ø Filetée / Ø Threaded (mm)	Longueur/ Length (mm)	Long. filetée / Threaded length (mm)	Code SS
3	4	200	20	307124
			30	307125
			40	307126
4	5	200	40	307021
		250	40	307022
		250	50	307023
		300	60	307024

Guide de perçage
Drill guide

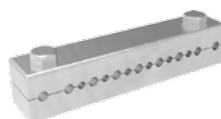

Taille / Size (mm)	Code SS
Ø3 & Ø4	201421
Ø4 & Ø5	201422
Ø3, Ø4 & Ø5	201423

201401 Vilebrequin
Drill brace



N1
007

1 FIXATEURS EXTERNES LATERAL NHI
LATERAL EXTERNAL FIXATORS NH I

Mandrin pour fiche
Chuck for pin



Longueur/Length (mm)	Ø3(mm)	Ø4(mm)	Ø5(mm)
40	201411	201412	201413
90	201414	201415	201416
140	201417	201418	201419

201501 **Kit pour fémur type 1**
Femoral frame type 1

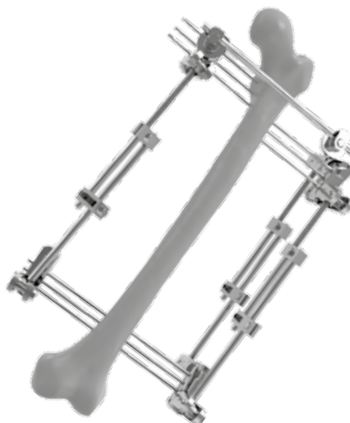

Code	Description	Qté.
201002	Etau à rotule universel grand model. Universal joint clamp large model.	02
201022	Etau à rotule universel double grand model. Double universal joint clamp large model.	02
201101	Couplage d'articulation Ø8/Ø8 mm. Articulation coupling Ø8/Ø8 mm.	02
201223	Barre d'union droite Ø8x200 mm. Straight connecting rod Ø8x200 mm.	01
201232	Barre de connexion ajustable Ø8x150 mm. Adjustable connecting rod Ø8x150 mm.	01
201233	Barre de connexion ajustable Ø8x200 mm. Adjustable connecting rod Ø8x200 mm.	01
201234	Barre de connexion ajustable Ø8x250 mm. Adjustable connecting rod Ø8x250 mm.	01
307041	Demi-fiche à os corticale, perforante, auto taraudante Ø4x120 mm. Self drilling tapping cortical bone pin Ø4x120 mm.	06
307024	Fiche transfixiante Ø4x300 mm à filetage central Ø5x60 mm. Transfixing pin Ø4x300 mm with central thread Ø5x60 mm.	03

N1
009

1 FIXATEURS EXTERNES LATERAL NHI
LATERAL EXTERNAL FIXATORS NH I

201502 Kit pour fémur type 2
Femoral frame type 2

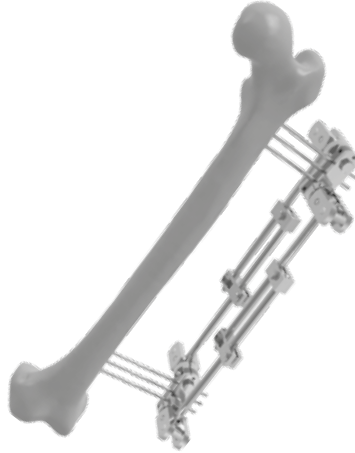

De	Description	Qté.
201022	Etau à rotule universel double grand model. Double universal joint clamp large model.	02
201233	Barre de connexion ajustable Ø8x200 mm. Adjustable connecting rod Ø8x200 mm.	02
307044	Demi-fiche à os cortical, perforante, auto taraudante Ø4x180 mm. Self drilling tapping cortical bone pin Ø4x180 mm.	06

1 FIXATEURS EXTERNES LATERAL NHI
LATERAL EXTERNAL FIXATORS NH I

201503 Kit pour fémur type 3
Femoral frame type 3



Code	Description	Qté.
201002	Etai à rotule universel grand model. Universal joint clamp large model.	02
201022	Etai à rotule universel double grand model. Double universal joint clamp large model.	02
201222	Barre d'union droite Ø8x150 mm. Straight connecting rod Ø8x150 mm.	01
201233	Barre de connexion ajustable Ø8x200 mm. Adjustable connecting rod Ø8x200 mm.	01
201234	Barre de connexion ajustable Ø8x250 mm. Adjustable connecting rod Ø8x250 mm.	01
307044	Demi-fiche à os cortical, perforante, auto taraudante Ø4x180 mm. Self drilling tapping cortical bone pin Ø4x180 mm.	06

1 FIXATEURS EXTERNES LATERAL NHI
LATERAL EXTERNAL FIXATORS NH I

201504 Kit pour fémur type 4
Femoral frame type 4



Code	Description	Qté.
201002	Etau à rotule universel grand model. Universal joint clamp large model.	02
201022	Etau à rotule universel double grand model. Double universal joint clamp large model.	03
201101	Couplage d'articulation Ø8/Ø8 mm. Articulation coupling Ø8/Ø8 mm.	01
201222	Barre d'union droite Ø8x150 mm Straight connecting rod Ø8x150 mm	01
201224	Barre d'union droite Ø8x250 mm Straight connecting rod Ø8x250 mm	02
201225	Barre d'union droite Ø8x300 mm Straight connecting rod Ø8x300 mm	01
307042	Demi-fiche à os cortical, perforante, auto taradante Ø4x150 mm. Self drilling tapping cortical bone pin Ø4x150 mm.	06
307023	Fiche transfixiante Ø4x250 à filetage central Ø5x50 mm Transfixing pin Ø4x250 with central thread Ø5x50 mm	03

N1
012

1 FIXATEURS EXTERNES LATERAL NHI
LATERAL EXTERNAL FIXATORS NH I

201521 Kit pour tibia type 1
Tibial frame type 1

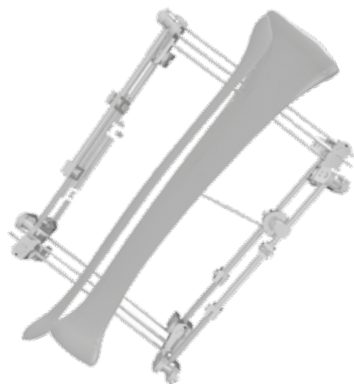

Code	Description	Qté.
201042	Etau à rotule universel avec tige grand model Universal joint clamp with rod large model	02
201022	Etau à rotule universel double grand model. Double universal joint clamp large model.	02
201101	Couplage d'articulation Ø8/Ø8 mm. Articulation coupling Ø8/Ø8 mm.	02
201106	Couplage d'articulation Ø8/Ø4 mm. Articulation coupling Ø8/Ø4 mm.	01
201232	Barre de connexion ajustable Ø8x150 mm. Adjustable connecting rod Ø8x150 mm.	04
307024	Fiche transfixiante Ø4x300 à filetage central Ø5x60 mm. Transfixing pin Ø4x300 with central thread Ø5x60 mm.	06
304041	Demi-fiche à os cortical, perforante, auto taraudante Ø4x120 mm. Self drilling tapping cortical bone pin Ø4x120 mm.	01

N1
013

1 FIXATEURS EXTERNES LATERAL NHI
LATERAL EXTERNAL FIXATORS NH I

201522 **Kit pour tibia type 2**
Tibial frame type 2

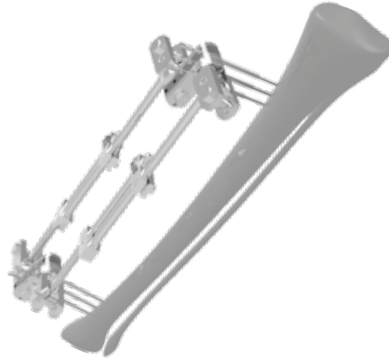

Code	Description	Qté.
201022	Etai à rotule universel double grand model. Double universal joint clamp large model.	02
201232	Barre de connexion ajustable Ø8x150 mm. Adjustable connecting rod Ø8x150 mm.	02
307043	Demi-fiche à filetage cortical, perforante, auto taraudante Ø4x150 mm. Self drilling tapping pin with cortical thread Ø4x150 mm.	06

1 FIXATEURS EXTERNES LATERAL NHI
LATERAL EXTERNAL FIXATORS NH I

201523 Kit pour tibia type 3
Tibial frame type 3

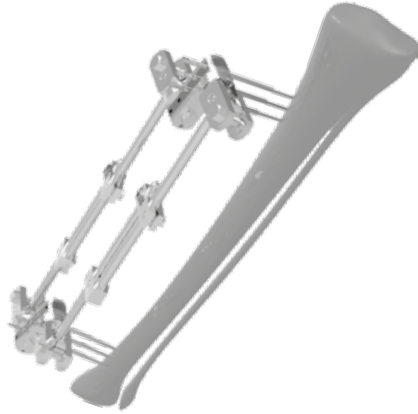

Code	Description	Qté.
201002	Etau à rotule universel grand model. Universal joint clamp large model.	02
201223	Barre d'union droite Ø8x200 mm. Straight connecting rod Ø8x200 mm.	01
307041	Demi-fiche à os cortical, perforante, auto taraudante Ø4x120 mm. Self drilling tapping cortical bone pin Ø4x120 mm.	04

1 FIXATEURS EXTERNES LATERAL NHI
LATERAL EXTERNAL FIXATORS NH I

201524 **Kit pour tibia type 4**
Tibial frame type 4



Code	Description	Qté.
201002	Etai à rotule universel grand model. Universal joint clamp large model.	02
201022	Etai à rotule universel double grand model. Double universal joint clamp large model.	02
201232	Barre de connexion ajustable Ø8x150 mm. Adjustable connecting rod Ø8x150 mm.	02
201022	Barre d'union droite Ø8x200 mm. Straight connecting rod Ø8x200 mm.	01
307044	Demi-fiche à filetage cortical, perforante, auto taraudante Ø4x180 mm. Self drilling tapping cortical bone pin Ø4x180 mm.	06

1 FIXATEURS EXTERNES LATERAL NHI
LATERAL EXTERNAL FIXATORS NH I

201541 Kit pour humérus type 1
Humeral frame type 1

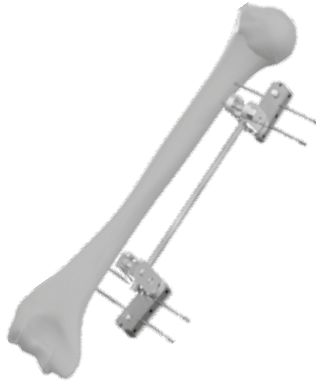

Code	Description	Qté.
201012	Etau à rotule universel petit model. Universal joint clamp small model.	02
201243	Barre de connexion ajustable Ø5x200 mm. Adjustable connecting rod Ø5x200 mm.	01
307143	Demi-fiche à os cortical, perforante, auto taroudante Ø3x110 mm. Self drilling tapping cortical bone pin Ø3x110 mm.	04

1 FIXATEURS EXTERNES LATERAL NHI
LATERAL EXTERNAL FIXATORS NH I

201551 Kit pour avant bras type 1
Forearm frame type 1

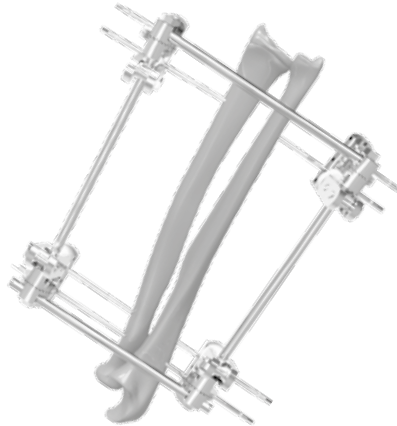

Code	Description	Qté.
201052	Etau à rotule universel avec tige petit model. Universal joint clamp with rod small model.	04
201102	Couplage d'articulation Ø8/5 mm. Articulation coupling Ø8/5 mm.	04
201243	Barre de connexion ajustable Ø5x200 mm. Adjustable connecting rod Ø5x200 mm.	02
201221	Barre d'union droite Ø8x100 mm. Straight connecting rod Ø8x100 mm.	02
307143	Demi-fiche à os cortical, perforante, auto taraudante Ø3x110 mm. Self drilling tapping cortical bone pin Ø3x110 mm.	08

201561 Kit pour bassin
Pelvic frame type 1



Code	Description	Qté.
201302	Etau à rotule parallèle grand model. Universal joint clamp large model.	02
201101	Couplage d'articulation Ø8/8 mm. Articulation coupling Ø8/8 mm.	02
201223	Barre d'union droite Ø8x200 mm. Straight connecting rod Ø8x200 mm.	01
201225	Barre d'union droite Ø8x300 mm. Straight connecting rod Ø8x300 mm.	02
307041	Demi-fiche à os cortical, perforante, auto taradante Ø4x120 mm. Self drilling tapping cortical bone pin Ø4x120 mm.	06
201181	Pivot d'union à trous orthogonaux grand model Swivelling coupling with orthogonal holes large model.	02

N1
019

1 FIXATEURS EXTERNES LATERAL NHI
LATERAL EXTERNAL FIXATORS NH I

502008 Clé mixte Hex.8.
Mixed wrench Hex.8.



502002 Clé mixte Hex.10.
Mixed wrench Hex.10.



506007 Clé en T carré 7 mm.
T-Wrench square 7 mm.



201401 Vilebrequin
Drill brace



2 FIXATEURS EXTERNES LATERAL NHII
LATERAL EXTERNAL FIXATORS NH II

206201 Etau porte fiche à 4 trous
pour fiche Ø3 et 4 mm.
4-Hole pin clamp for Ø3 and
4 mm pins.



206202 Etau porte fiche Ø3 mm,
péri-articulaire.
Peri-articular pin clamp for
Ø3 mm pins.



206211 Articulation barre d'union Ø5
/ Ø5 mm.
Rod Ø5 to rod Ø5 mm
coupling.



206212 Articulation fiche Ø3-4 /
barre d'union Ø5 mm.
Pin to rod coupling for
Ø3-4 pins / Ø5 mm rods.



206213 Articulation barre d'union
Ø5 / Ø8 mm.
Rod Ø5 to rod Ø8 mm
coupling.



N2
021

2 FIXATEURS EXTERNES LATERAL NHII
LATERAL EXTERNAL FIXATORS NH II

206214 Connecteur barre Ø5 / tube
Ø15 mm.
Tube to rod coupling for Ø15
tubes / Ø5 mm rods.

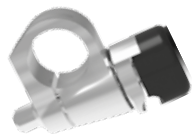

201413 Mandrin pour demi fiche
Ø5x40 mm.
Handle for pin Ø5x40 mm.



201412 Mandrin pour demi fiche
Ø4x40 mm.
Handle for pin Ø4x40 mm.



201411 Mandrin pour demi fiche
Ø3x40 mm.
Handle for pin Ø3x40 mm.



206221 Tige denté droite Ø5 mm.
Straight post Ø5 mm.



2 FIXATEURS EXTERNES LATERAL NHII
LATERAL EXTERNAL FIXATORS NH II

206222 Tige denté coudé 30°, Ø5 mm.
30° Angled post Ø5 mm.



Barre d'union, Ø5 mm.
Connecting rod, Ø5 mm.



Longueur/Length (mm)	Code (Carbon fibre)	Code (Alu)
65	206230	206240
100	206231	206241
150	206232	206242
200	206233	206243
250	206234	206244
300	206235	206245

Barre d'union semi-circulaire Ø5 mm.
Semi-circular curved rod Ø5 mm.



L (mm)	Code Inox
111	206260
146	206261

N2
023

2 FIXATEURS EXTERNES LATERAL NHII
LATERAL EXTERNAL FIXATORS NH II

Demi-fiche à filetage cortical, perforante, auto taraudante
Self drilling tapping pin with cortical thread



Ø (mm)	Longueur/Length (mm)	Filetée / Threaded (mm)	Code SS
3	60	15	307141
	80	20	307142
	110	25	307143
4	120	40	307041
	150	40	307042
	150	45	307043
	180	50	307044
	200	50	307045
5	120	50	307241
	150	50	307242
	180	50	307243
	200	60	307244

2 FIXATEURS EXTERNES LATERAL NHII
LATERAL EXTERNAL FIXATORS NH II

206280 Tige articulée Ø5 mm, pour le coude.
Articulated rod Ø5 mm, for elbow.



206270 Tube de compression / distraction.
Compression/Distraktion tube.



506207 Clé en T, carré 5 mm.
T-wrench square 5 mm.



506206 Clé de stabilisation / réduction Ø5 mm.
Stabilization / Reduction wrench Ø5 mm.



201401 Vilebrequin
Drill brace



506205 Clé dynamométrique carré 5 mm.
Dynamometric wrench square 5 mm.



N2
025

506200F Instrumentation de pose pour NH2 membre supérieur NH2 upper limb instrument set



Code	Description	Qté.
506200FB	Boite vide avec filtre. / Sterile container systems.	1
506200FP1	Panier. / Rack.	1
506200FP2	Panier. / Rack.	1
506200FP3	Panier. / Rack.	1
201413	Mandrin pour fiche Ø5x40 mm. / Handle for pin Ø5x40 mm.	1
201412	Mandrin pour fiche Ø4x40 mm. Handle for pin Ø4x40 mm..	1
201411	Mandrin pour fiche Ø3x40 mm. Handle for pin Ø3x40 mm.	1
201401	Vilebrequin. / Drill brace.	1
506206	Clé de stabilisation PM. / Stabilization wrench PM.	1
506205	Clé dynamométrique carré 5 mm. Dynamometric wrench, square 5 mm.	1
506207	Clé en T carré 5 mm. T-wrench square 5 mm.	1
206261	Barre d'union semi circulaire en aluminium Ø5x146 mm. Semi-circular curved rod-aluminium Ø5x146 mm.	1
206260	Barre d'union semi circulaire en aluminium Ø5x111 mm. Semi-circular curved rod-aluminium Ø5x111 mm.	1
307243	1/2 fiche à os cortical Ø5x180 F50 mm. Self drilling cortical bone pin Ø5x180 F50 mm.	5
307242	1/2 fiche à os cortical Ø5x180 F50 mm. Self drilling cortical bone pin Ø5x180 F50 mm.	5
307044	1/2 fiche à os cortical Ø4x180 F50 mm. Self drilling cortical bone pin Ø4x180 F50 mm.	5
307043	1/2 fiche à os cortical Ø4x150 F45 mm. Self drilling cortical bone pin Ø4x150 F45 mm.	5
307143	1/2 fiche à os cortical Ø3x110 F22 mm. Self drilling cortical bone pin Ø3x110 F22 mm.	5

2 FIXATEURS EXTERNES LATERAL NHII
LATERAL EXTERNAL FIXATORS NH II

Code	Description	Qté.
307142	1/2 fiche à os cortical Ø3x80 F20 mm. Self drilling cortical bone pin Ø3x80 F20 mm.	5
307141	1/2 fiche à os cortical Ø3x60 F15 mm. Self drilling cortical bone pin Ø3x60 F15 mm.	5
206235	Barre d'union en fibre de carbone, Ø5x300 mm. Connecting rod-carbon, Ø5x300 mm.	5
206234	Barre d'union en fibre de carbone, Ø5x250 mm. Connecting rod-carbon, Ø5x250 mm.	5
206233	Barre d'union en fibre de carbone, Ø5x200 mm. Connecting rod-carbon, Ø5x200 mm.	5
206222	Tige denté Ø5 mm coudé 30°. 30° angled post Ø5 mm.	8
206221	Tige denté droite Ø5 mm. Straight post Ø5 mm.	8
206212	Articulation pour fiche Ø3-4 / barre d'union Ø5 mm. Pin to rod coupling for Ø3-4 pins / Ø5 mm rods.	16
206211	Articulation barre d'union Ø5 / Ø5 mm. Rod Ø5 to rod Ø5 mm coupling.	16
206201	Etau porte fiche 4 trous pour fiche Ø3 et 4 mm. 4-Hole pin clamp for Ø3 and 4 mm pins.	8

2 FIXATEURS EXTERNES LATERAL NHII
LATERAL EXTERNAL FIXATORS NH II

206001 Etiau porte fiche à 5 trous pour fiche Ø4, 5, & 6 mm.
5-Hole pin clamp for pins Ø4, 5, & 6 mm.



206002 Etiau porte fiche à 10 trous pour fiche Ø4, 5, & 6 mm.
10-Hole pin clamp for pins Ø4, 5, & 6 mm.



206003 Etiau porte fiche Ø5, 4 et 6 mm, pour le bassin.
Pelvic clamp for Ø5, 4, and 6 mm pins.



206011 Articulation barre d'union Ø8 / Ø8 mm.
Rod Ø8 to rod Ø8 mm coupling.



206012 Articulation fiche Ø5-4 / barre d'union Ø8 mm.
Pin to rod coupling for Ø5-4 mm pins / Ø8 mm rods.



206013 Articulation inversée, barre d'union Ø8 / fiche Ø5-4 mm.
Inverted pin to rod coupling Ø8 rods / Ø5-4 mm pins.



2 FIXATEURS EXTERNES LATERAL NHII
LATERAL EXTERNAL FIXATORS NH II

206014 Connecteur barre d'union
Ø8 / tube Ø20 mm.
Tube to rod coupling for Ø20
tube / Ø8 mm rods.



201413 Mandrin pour demi-fiche Ø5
mm.
Handle for Ø5 mm pin.



201412 Mandrin pour demi-fiche Ø4
mm.
Handle for Ø4 mm pin.



206021 Tige denté droite Ø8 mm.
Straight post Ø8 mm.



206022 Tige denté coudé 30°, Ø8
mm.
30° angled post Ø8 mm.



206023 Tige denté coudé 90°, Ø8
mm.
90° angled post Ø8 mm.



2 FIXATEURS EXTERNES LATERAL NHII
LATERAL EXTERNAL FIXATORS NH II

**Barre d'union, Ø8 mm.
Connecting rod, Ø8 mm.**



Longueur/Length (mm)	Code Carbone	Code Alu
65	206030	206050
100	206031	206051
150	206032	206052
200	206033	206053
250	206034	206054
300	206035	206055
350	206036	206056
400	206037	206057
450	206038	206058
500	206039	206059

2 FIXATEURS EXTERNES LATERAL NHII
LATERAL EXTERNAL FIXATORS NH II

Barre d'union semi-circulaire en aluminium Ø8 mm.
Semi-circular curved rod – aluminium Ø8 mm.



Longueur/Length (mm)	Code Alu
134	206090
174	206091
214	206092

Demi-fiche à filetage cortical, perforante, auto taraudante
Self drilling tapping pin with cortical thread



Ø (mm)	Longueur/Length (mm)	Filetée / Threaded (mm)	Code SS
3	60	12	307141
	80	20	307142
	110	25	307143
	120	35	307041
4	150	40	307042
	150	45	307043
	180	50	307044
	200	50	307045
5	120	50	307241
	150	50	307242
	180	50	307243
	200	60	307244

2 FIXATEURS EXTERNES LATERAL NHII
LATERAL EXTERNAL FIXATORS NH II

206100 Tube dynamisation / distraction.
Dynamization / distraction tube.



206101 Barre de compression / distraction.
Compression / distraction tube.



506006 Clé de stabilisation / réduction.
Stabilization / reduction wrench.



506007 Clé en T, carré 7 mm.
T-wrench square 7 mm.



506005 Clé dynamométrique carré 7 mm.
Dynamometric wrench square 7 mm.



506000F Instrumentation de pose pour NH2 membre inférieur NH2 lower limb Instruments set



Code	Description	Qté.
506000FB	Boite vide avec filtre. / Sterile container systems.	01
506000FP1	Panier. / Rack.	01
506000FP2	Panier. / Rack.	01
506000FP3	Panier. / Rack.	01
506005	Clé dynamométrique carré 7 mm. Dynamometric wrench, square 7 mm.	01
201413	Mandrin pour fiche Ø5x40 mm. / Handle for pin Ø5x40 mm.	01
201412	Mandrin pour fiche Ø4x40 mm. / Handle for pin Ø4x40 mm.	01
201401	Vilebrequin. / Drill brace.	01
506006	Clé de stabilisation GM. / Stabilization wrench GM.	01
506007	Clé en T carré 7 mm. / T-wrench square 7 mm.	01
206092	Barre d'union semi-circulaire en aluminium Ø8x214 mm. Semi-circular curved rod-aluminium Ø8x214 mm.	01
206091	Barre d'union semi-circulaire en aluminium Ø8x174 mm. Semi-circular curved rod-aluminium Ø8x174 mm.	01
206090	Barre d'union semi-circulaire en aluminium Ø8x134 mm. Semi-circular curved rod-aluminium Ø8x134 mm.	01
307244	1/2 fiche à os cortical Ø5x200 F 60 mm. Self drilling tapping cortical bone pin Ø5x200 F 60 mm.	05
307243	1/2 fiche à os cortical Ø5x180 F 50 mm. Self drilling tapping cortical bone pin Ø5x180 F 50 mm.	05
307242	1/2 fiche à os cortical Ø5x150 F 50 mm. Self drilling tapping cortical bone pin Ø5x150 F 50 mm.	05
307045	1/2 fiche à os cortical Ø4x200 F 50 mm. Self drilling tapping cortical bone pin Ø4x200 F 50 mm.	05
307044	1/2 fiche à os cortical Ø4x180 F 50 mm. Self drilling tapping cortical bone pin Ø4x180 F 50 mm.	05

2 FIXATEURS EXTERNES LATERAL NHII
LATERAL EXTERNAL FIXATORS NH II

Code	Description	Qté.
307043	1/2 fiche à os cortical Ø4x150 F 45 mm. Self drilling tapping cortical bone pin Ø4x150 F 45 mm.	05
206037	Barre d'union en fibre de carbone, Ø8x400 mm. Connecting rod-carbon, Ø8x400 mm.	05
206036	Barre d'union en fibre de carbone, Ø8x350 mm. Connecting rod-carbon, Ø8x350 mm.	05
206035	Barre d'union en fibre de carbone, Ø8x300 mm. Connecting rod-carbon, Ø8x300 mm.	05
206034	Barre d'union en fibre de carbone, Ø8x250 mm. Connecting rod-carbon, Ø8x250 mm.	05
206033	Barre d'union en fibre de carbone, Ø8x200 mm. Connecting rod-carbon, Ø8x200 mm.	05
206023	Tige denté coudée 90°, Ø8 mm. 90° angled post Ø8 mm.	04
206022	Tige denté coudée 30°, Ø8 mm. 30° angled post Ø8 mm.	08
206021	Tige denté droite Ø8 mm. Straight post Ø8 mm.	08
206012	Articulation fiche Ø4-5 / barre d'union Ø8 mm. Pin to rod coupling for Ø4-5 pins / Ø8 mm rods.	16
206011	Articulation barre d'union Ø8 / Ø8 mm. Rod Ø8 to rod Ø8 mm coupling.	16
206003	Etau porte fiche à Ø4,0 / Ø5,0 et Ø6 mm pour bassin. Pelvic clamp for Ø4,0 / Ø5,0 and Ø6 mm pins.	02
206002	Etau porte fiche à 10 trous. 10-Hole pin clamp.	02
206001	Etau porte fiche à 5 trous. 5-Hole pin clamp.	08

206000F Boite complète : Instruments et composants pour NHII 5 & NHII 8
Complete box : Instruments and components for NHII 5 & NHII 8

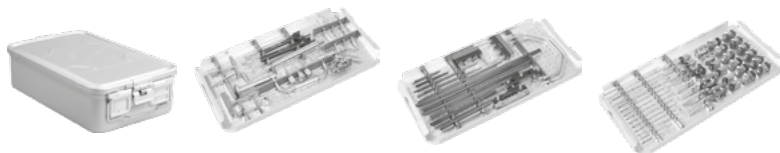

Code	Description	Qté.
206000FB	Boite vide avec filtre. / Sterile container systems.	01
206000FP1	Plateau. / Rack.	01
206000FP2	Plateau. / Rack.	01
206000FP3	Plateau. / Rack.	01
206022	Tige dentée Ø8 mm coudé 30°. / 30° angled post Ø8 mm.	16
206222	Tige dentée Ø5 mm coudé 30°. / 30° angled post Ø5 mm.	16
206021	Tige dentée droite Ø8 mm. / Straight post Ø8 mm.	08
206221	Tige dentée droite Ø5 mm. / Straight post Ø5 mm.	08
206001	Etau porte fiche à 5 trous pour fiche Ø4, 5 & 6 mm. 5-Hole pin clamp for Ø4, 5 & 6 mm pins.	08
206202	Etau porte fiche Ø3 mm, péri-articulaire. Peri-articular pin clamp for Ø3 mm pins.	01
206003	Etau porte fiche Ø4, 5 & 6 mm pour le bassin. Pelvic clamp for Ø4, 5 & 6 mm pins.	02
206002	Etau porte fiche à 10 trous pour fiche Ø4, 5 & 6 mm. 10-Hole pin clamp for Ø4 5 & 6 mm pins.	02
206201	Etau porte fiche à 4 trous pour fiche Ø3 et 4 mm. 4-Hole pin clamp for Ø3 and 4 mm pins.	08
206012	Articulation fiche Ø4-5 mm / barre d'union Ø8 mm. Pin to rod coupling for Ø4-5 pins / Ø8 mm rods.	16
206011	Articulation barre d'union Ø8 / Ø8 mm. Rod Ø8 to rod Ø8 mm coupling.	16
206212	Articulation fiche Ø3-4 mm / barre d'union Ø5 mm. Pin to rod coupling for Ø3-4 pins / Ø5 mm rods.	04
206211	Articulation barre d'union Ø5 / Ø5 mm. Rod Ø5 to rod Ø5 mm coupling.	16

2 FIXATEURS EXTERNES LATERAL NHII
LATERAL EXTERNAL FIXATORS NH II

Code	Description	Qté.
506006	Clé de stabilisation / réduction Ø8 mm. Stabilization / reduction wrench Ø8 mm.	01
506206	Clé de stabilisation / réduction Ø5 mm. Stabilization / reduction wrench Ø5 mm.	01
506105	Clé en L carré 7 mm. L-wrench square 7mm.	01
506007	Clé en T, carré 7 mm. T-wrench square 7 mm.	01
506207	Clé en T, carré 5 mm. T-wrench square 5 mm.	01
506108	Clé à fourche Hex. 5-7 et 10. Spanner Hex. 5-7 and 10.	01
506106	Ecrou de serrage rapide carré 5 et 7 mm. Quick lock nut square 5 and 7 mm.	01
506107	Tendeur pour articulation. Tensioner for articulation.	01
307142	Demi fiche à os cortical Ø3x80x20 mm. Self drilling tapping cortical bone pin Ø3x80x20 mm.	08
307041	Demi fiche à os spongieux Ø4x120x40 mm. Self drilling tapping cancellous bone pin Ø4x120x40 mm.	08
307042	Demi fiche à os cortical Ø4x150x40 mm. Self drilling tapping cortical bone pin Ø4x150x40 mm.	08
307044	Demi fiche à os cortical Ø4x180x50 mm. Self drilling tapping cortical bone pin Ø4x180x50 mm.	08
307242	Demi fiche à os cortical Ø5x150x40 mm. Self drilling tapping cortical bone pin Ø5x150x40 mm.	08
307201	Fiche à os cortical Ø5x120x40 mm. Cortical bone pin Ø5x120x40 mm.	04
307243	Demi fiche à os cortical Ø5x180x50 mm. Self drilling tapping cortical bone pin Ø5x180x50 mm.	08
206090-150	Barre d'union semi-circulaire en aluminium Ø8x150 mm. Semi-circular curved rod-aluminium Ø8x150 mm.	02
206090-165	Barre d'union semi-circulaire en aluminium Ø8x165 mm. Semi-circular curved rod-aluminium Ø8x165 mm.	02
206091-200	Barre d'union semi-circulaire en aluminium Ø8x200 mm. Semi-circular curved rod-aluminium Ø8x200 mm.	02
206232	Barre d'union en carbone Ø5x150 mm. Connecting rod-carbon, Ø5x150 mm.	04

2 FIXATEURS EXTERNES LATERAL NHII
LATERAL EXTERNAL FIXATORS NH II

Code	Description	Qté.
206233	Barre d'union en carbone Ø5x200 mm. Connecting rod-carbon, Ø5x200 mm.	04
206234	Barre d'union en carbone Ø5x250 mm. Connecting rod-carbon, Ø5x250 mm.	04
206235	Barre d'union en carbone Ø5x300 mm. Connecting rod-carbon, Ø5x300 mm.	04
206037	Barre d'union en carbone Ø8x400 mm. Connecting rod-carbon, Ø8x400 mm.	04
206036	Barre d'union en carbone Ø8x350 mm. Connecting rod-carbon, Ø8x350 mm.	04
206035	Barre d'union en carbone Ø8x300 mm. Connecting rod-carbon, Ø8x300 mm.	04
206034	Barre d'union en carbone Ø8x250 mm. Connecting rod-carbon, Ø8x250 mm.	04
100057-145	Mèche Ø3x145 mm pour mandrin universel. Drill Ø3x145 mm for universal chuck.	01
100058	Mèche Ø3,8x195 mm pour mandrin universel. Drill Ø3,8x195 mm for universal chuck.	01
506109	Guide mèche simple Ø3 (Ø3,1xØ4x48) mm. Wire guide Ø3 (Ø3,1xØ4x48) mm.	01
506110	Guide mèche simple Ø3,8 (Ø3,9xØ5x77) mm. Wire guide Ø3,8 (Ø3,9xØ5x77) mm.	01
506111	Guide mèche avec plaque de maintien Ø4 (Ø4,1xØ5x42) mm. Drill guide with plate holding Ø4 (Ø4,1xØ5x42) mm.	01
506112	Guide mèche avec plaque de maintien Ø5 (Ø5,1xØ6x70) mm. Drill guide with plate holding Ø5 (Ø5,1xØ6x70) mm.	01
506113	Trocart Ø3x60 mm. Trocard Ø3x60 mm.	01
506114	Trocart Ø3,8x88 mm. Trocard Ø3,8x88 mm.	01

206301 Kit pour le poignet
Wrist set

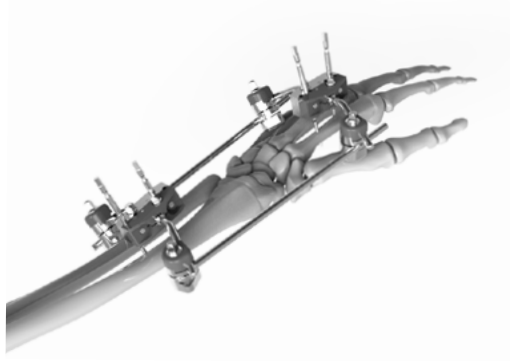

Code	Description	Qté.
206201	Etau porte fiche à 4 trous pour fiche Ø3 / Ø4 mm. 4-Hole pin clamp for Ø3 and Ø4 mm pins.	2
206211	Articulation Ø5 / Ø5 mm. Rod Ø5 to Ø5 mm coupling.	4
307142	Demi fiche Ø3x80x20 mm. Self drilling tapping cortical bone pin Ø3x80x20 mm.	4
206233	Barre d'union Ø5x200 mm carbone. Connection rod, Ø5x200 mm carbone.	2
206222	Tige denté coudée 30° / Ø5 mm. 30° angled post Ø5 mm.	4

206302 Kit pour l'avant-bras
Forearm set

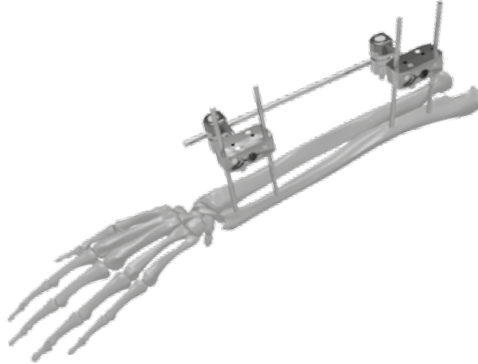

Code	Description	Qté.
206201	Etau porte fiche à 4 trous pour fiche Ø3 et 4 mm. 4-Hole pin clamp for Ø3 and 4 mm pins.	2
206211	Articulation Ø5 / Ø5 mm. Rod Ø5 to Ø5 mm coupling.	2
307041	Demi fiche Ø4x120x40 mm. Self drilling tapping cortical bone pin Ø4x120x40 mm.	4
206233	Barre d'union Ø5x200 mm carbone. Connection rod, Ø5x200 mm carbone.	1
206221	Tige denté droite Ø5 mm. Straight post Ø5 mm.	2

206303 Kit pour le coude
Elbow set



Code	Description	Qté.
206001	Etau porte fiche à 5 trous pour fiche Ø5 mm. 5-Hole pin clamp for Ø5 mm pins.	1
206201	Etau porte fiche à 4 trous pour fiche Ø4 mm. 4-Hole pin clamp for Ø4 mm pins.	1
206022	Tige denté coudé 30° / Ø8 mm. 30° angled post Ø8 mm.	1
206221	Tige denté droite Ø5 mm. Straight post Ø5 mm.	1
206233	Barre d'union Ø5x200 mm carbone. Connecting rod, Ø5x200 mm carbone.	1
206211	Articulation barre Ø5 / Ø5 mm. Rod Ø5 to Ø5 mm coupling.	1
307041	Demi fiche à os corticale Ø4x120x40 mm. Self drilling tapping cortical bone pin Ø4x120x40 mm.	2
307241	Demi fiche à os corticale Ø5x120x50 mm. Self drilling tapping cortical bone pin Ø5x120x50 mm.	2
206012	Articulation barre Ø5 / Ø8 mm. Rod Ø5 to Ø8 mm coupling.	1

206304 Kit pour l'humérus type 1
Humerus set type 1



Code	Description	Qté.
206001	Etau porte fiche à 5 trous pour fiche Ø5 mm. 5-Hole pin clamp for Ø5 mm pins.	2
206022	Tige denté coudé 30° / Ø8 mm. 30° angled post Ø8 mm.	2
206034	Barre d'union Ø8x250 mm carbone. Connecting rod, Ø8x250 mm carbone.	1
206011	Articulation barre Ø8 / Ø8 mm. Rod Ø8 to Ø8 mm coupling.	2
307042	Demi fiche à os corticale Ø4x150x40 mm. Self drilling tapping cortical bone pin Ø4x150x40 mm.	4

206305 Kit pour l'humérus type 2
Humerus set type 2



Code	Description	Qté.
206001	Etau porte fiche à 5 trous pour fiche Ø4 mm. 5-Hole pin clamp for Ø4 mm pins.	1
206034	Barre d'union Ø8x250 mm carbone. Connecting rod, Ø8x250 mm carbone.	2
206022	Tige denté coudé 30°/Ø8 mm. 30° angled post Ø8 mm.	2
206011	Articulation barre Ø8 / Ø8 mm. Rod Ø8 to Ø8 mm coupling.	4
206012	Articulation fiche Ø4 / barre Ø8 mm. Pin Ø4 to rod Ø8 mm coupling.	2
206033	Barre d'union Ø8x200 mm carbone. Connecting rod, Ø8x200 mm carbone.	1
307042	Demi fiche à os corticale Ø4x150x40 mm. Self drilling tapping cortical bone pin Ø4x150x40 mm.	4

206306 Kit pour le bassin
Pelvic set

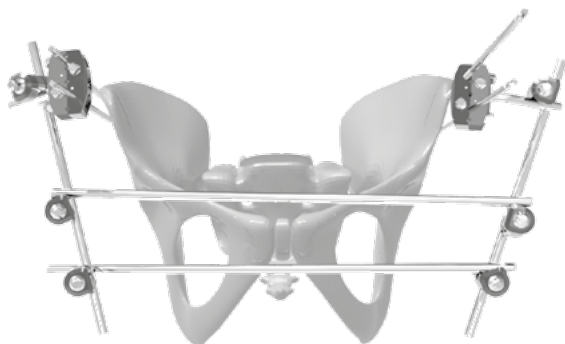

Code	Description	Qté.
206001	Etau porte fiche à 5 trous pour fiche Ø5 mm. 5-Hole pin clamp for Ø5 mm pins.	2
206036	Barre d'union Ø8x350 mm carbone. Connecting rod, Ø8x350 mm carbone.	2
206022	Tige denté coudé 30° / Ø8 mm. 30° angled post Ø8 mm.	2
206011	Articulation barre Ø8 / Ø8 mm. Rod Ø8 to Ø8 mm coupling.	6
206033	Barre d'union Ø8x200 mm carbone. Connecting rod, Ø8x200 mm carbone.	2
307243	Demi fiche à os corticale Ø5x180x50 mm. Self drilling tapping cortical bone pin Ø5x180x50 mm.	4

N2
043

206307 Kit pour le fémur type 1
Femur set type 1



Code	Description	Qté.
307243	Demi fiche à os corticale Ø5x180 mm. Self drilling tapping cortical bone pin Ø5x180 mm.	4
206012	Articulation fiche Ø5 / barre Ø8 mm. Pin to rod coupling for Ø5 pins / Ø8 mm rods.	4
206011	Articulation barre Ø8 / Ø8 mm. Rod to rod coupling for Ø8 / Ø8 mm rods.	2
206034	Barre d'union Ø8x250 mm carbone. Connecting rod, Ø8x250 mm carbone.	1
206035	Barre d'union Ø8x300 mm carbone. Connecting rod, Ø8x300 mm carbone.	1
206036	Barre d'union Ø8x350 mm carbone. Connecting rod, Ø8x350 mm carbone.	1

206308 Kit pour le fémur type 2
Femur set type 2

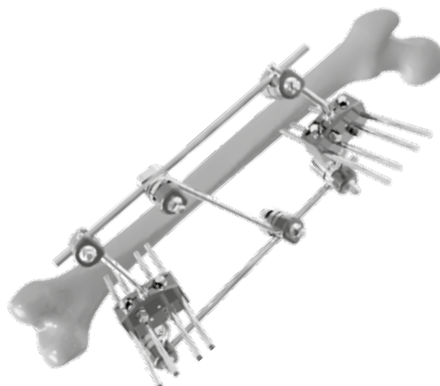

Code	Description	Qté.
206022	Tige denté coudé 30° / Ø8 mm. 30° angled post Ø8 mm.	4
307243	Demi fiche à os corticale Ø5x180 mm. Self drilling tapping cortical bone pin Ø5x180 mm.	8
206011	Articulation barre Ø8 / Ø8 mm. Rod Ø8 to Ø8 mm coupling.	6
206001	Etau porte fiche à 5 trous pour fiche Ø5 mm. 5-Hole pin clamp for Ø5 mm pins.	2
206034	Barre d'union Ø8x250 mm carbone. Connecting rod, Ø8x250 mm carbone.	1
206035	Barre d'union Ø8x300 mm carbone. Connecting rod, Ø8x300 mm carbone.	2

206309 Kit pour le fémur type 3
Femur set type 3

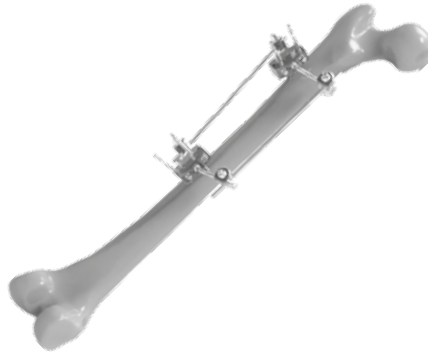

Code	Description	Qté.
206001	Etau porte fiche à 5 trous pour fiche Ø5 mm. 5-Hole pin clamp for Ø5 mm pins.	2
206022	Tige denté coudé 30° / Ø8 mm. 30° angled post Ø8 mm.	4
206034	Barre d'union Ø8x250 mm carbone. Connecting rod, Ø8x250 mm carbone.	2
206011	Articulation barre Ø8 / Ø8 mm. Rod Ø8 to Ø8 mm coupling.	4
307242	Demi fiche à os corticale Ø5x150x50 mm. Self drilling tapping cortical bone pin Ø5x150x50 mm.	4

206310 Kit pour le genou
Knee set



Code	Description	Qté.
206001	Etau porte fiche à 5 trous pour fiche Ø5 mm. 5-Hole pin clamp for Ø5 mm pins.	2
206036	Barre d'union Ø8x350 mm carbone. Connecting rod, Ø8x350 mm carbone.	4
206022	Tige denté coudé 30° / Ø8 mm. 30° angled post Ø8 mm.	4
206011	Articulation barre Ø8 / barre Ø8 mm. Rod Ø8 to Ø8 mm coupling.	10
206012	Articulation fiche Ø5 / barre Ø8 mm. Pin to rod coupling for Ø5 pins / Ø8 mm rods.	3
206034	Barre d'union Ø8x250 mm carbone. Connecting rod, Ø8x250 mm carbone.	1
307242	Demi fiche à os corticale Ø5x150x50 mm. Self drilling tapping cortical bone pin Ø5x150x50 mm.	7
206091	Barre d'union semi-circulaire en aluminium. Semi-circular curved rod-aluminium.	1

N2
047

206311 Kit pour le tibia type 1
Tibia set type 1

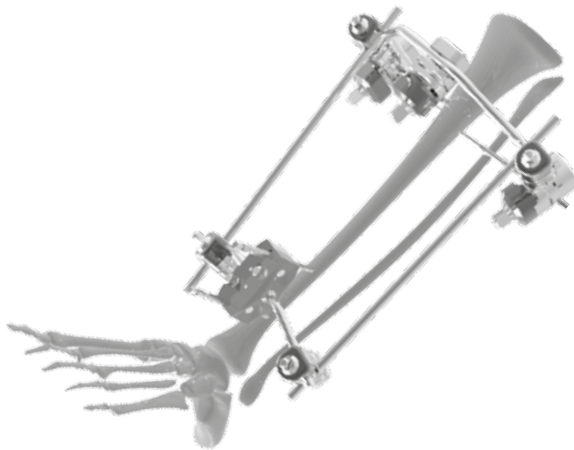

Code	Description	Qté.
206001	Etau porte fiche à 5 trous pour fiche Ø5 mm. 5-Hole pin clamp for Ø5 mm pins.	1
206036	Barre d'union Ø8x350 mm carbone. Connecting rod, Ø8x350 mm carbone.	2
206022	Tige denté coudé 30° / Ø8 mm. 30° angled post Ø8 mm.	2
206011	Articulation barre Ø8 / barre Ø8 mm. Rod Ø8 to Ø8 mm coupling.	4
206012	Articulation fiche Ø5 / barre Ø8 mm. Pin to rod coupling for Ø5 pins / Ø8 mm rods.	3
307242	Demi fiche à os corticale Ø5x150x50 mm. Self drilling tapping cortical bone pin Ø5x150x50 mm.	5
206091	Barre d'union semi-circulaire en aluminium. Semi-circular curved rod-aluminium.	1

206312 Kit pour la cheville type 1
Ankle set type 1



Code	Description	Qté.
206036	Barre d'union Ø8x350 mm carbone. Connecting rod, Ø8x350 mm carbone.	2
206011	Articulation barre Ø8 mm / barre Ø8 mm. Rod Ø8 to Ø8 mm coupling.	3
206034	Barre d'union Ø8x250 mm carbone. Connecting rod, Ø8x250 mm carbone.	1
206012	Articulation fiche Ø5 / barre Ø8 mm. Pin to rod coupling for Ø5 pins / Ø8 mm rods.	4
307242	Demi fiche à os corticale Ø5x150x50 mm. Self drilling tapping cortical bone pin Ø5x150x50 mm.	4

206313 Kit pour la cheville type 2
Ankle set type 2

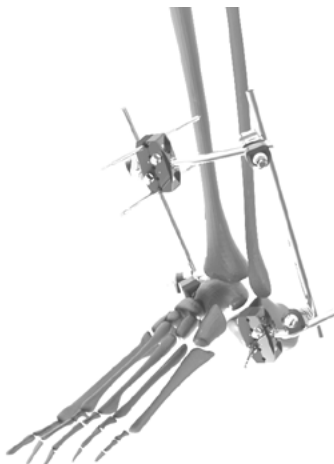

Code	Description	Qté.
206001	Etau porte fiche à 5 trous pour fiche Ø5 mm. 5-Hole pin clamp for Ø5 mm pins.	3
206022	Tige denté coudé 30° / Ø8 mm. 30° angled post Ø8 mm.	4
206034	Barre d'union Ø8x250 carbone. Connecting rod, Ø8x250 mm carbone.	2
206011	Articulation barre Ø8 / barre Ø8 mm. Rod Ø8 to Ø8 mm coupling.	4
307021	Fiche transfixante à filetage central Ø4x200x40 mm. Transfixing pin with central thread Ø4x200x40 mm.	2
307242	Demi fiche à os corticale Ø5x150x50 mm. Self drilling tapping cortical bone pin Ø5x150x50 mm.	2

206315 Kit pour le poignet, avec compression et distraction **Compression and distraction wrist set**



Code	Description	Qté.
206201	Etau porte fiche à 4 trous pour fiche Ø3 / Ø4 mm. 4-Hole pin clamp for Ø3 / Ø4 mm pins.	2
206222	Tige denté coudé 30° / Ø5 mm. 30° angled post Ø5 mm.	2
206214	Connecteur barre Ø5 / tube Ø15 mm. Tube to rod coupling for Ø15 tubes /Ø5 mm rods.	2
206270	Tube de compression / distraction Compression / distraction tube.	1
307041	Demi fiche à os corticale Ø4x120x40 mm. Self drilling tapping cortical bone pin Ø4x120x40 mm.	4

206316 Kit pour le tibia type 2
Tibia set type 2



Code	Description	Qté.
206035	Barre d'union Ø8x300 mm. Connecting rod, Ø8x300 mm.	2
206001	Etau porte fiche à 5 trous pour fiche Ø5 mm. 5-Hole pin clamp for Ø5 mm pins.	2
206011	Articulation barre d'union Ø8 / Ø8 mm. Rod Ø8 to Ø8 mm coupling.	4
206022	Tige denté coudé 30° / Ø8 mm. 30° angled post Ø8 mm.	4
307242	Demi fiche à os corticale Ø5x150x50 mm. Self drilling tapping cortical bone pin Ø5x150x50 mm.	4

206314 Kit articulé pour le coude latéral et médial
Unilatéral frame set (Latéral & Médial)



Code	Description	Qté.
206280	Tige articulé pour le coude Ø5 mm. Articulated rod Ø5 mm, for elbow.	1
206212	Articulation fiche Ø3-Ø4 / barre Ø5 mm. Pin to rod coupling for Ø3-Ø4 pins / Ø5 mm rods.	4
307041	Demi fiche à os corticale Ø4x120x40 mm. Self drilling tapping cortical bone pin Ø4x120x40 mm.	4

206317 Kit articulé pour le coude bilatéral
Bilatéral frame



Code	Description	Qté.
206280	Tige articulé pour le coude Ø5 mm. Articulated rod Ø5mm, for elbow.	2
206212	Articulation fiche Ø3-Ø4 / barre Ø5 mm. Pin to rod coupling for Ø3-Ø4 pins / Ø5 mm rods.	8
307041	Demi fiche à os corticale Ø4x120x40 mm. Self drilling tapping cortical bone pin Ø4x120x40 mm.	8

Mini fixateur articulé / Articulated mini fixator



207001 Kit pour mini fixateur articulé court Short articulated mini fixator kit

Description	Qté.
Mini fixateur articulé court / Short articulated mini fixator.	1
Fiche à os cortical Ø1,5x35 mm / Cortical bone pin Ø1,5x35 mm.	4
Clé en T / T-wrench.	1
Clé en L Hex.3 / L-wrench Hex.3.	1

207002 Kit pour mini fixateur articulé standard Standard articulated mini fixator kit

Description	Qté.
Mini fixateur articulé standard / Standard articulated mini fixator.	1
Fiche à os cortical Ø1,5x35 mm / Cortical bone pin Ø1,5x35 mm.	4
Clé en T pour fiche / T-wrench for pin.	1
Clé en L Hex.3 / L-wrench Hex.3.	1

207003 Kit pour mini fixateur articulé long Long articulated mini fixator kit

Description	Qté.
Mini fixateur articulé long / Long articulated mini fixator.	1
Fiche à os cortical Ø1,5x35 mm / Cortical bone pin Ø1,5x35 mm.	4
Clé en T pour fiche / T-wrench for pin.	1
Clé en L Hex.3 / L-wrench Hex.3.	1

Mini fixateur droit / Straight mini fixator



207010 Kit pour mini fixateur droit court Straight short mini fixator kit

Description	Qté.
Mini fixateur droit court / Straight short mini fixator.	1
Fiche à os cortical Ø1,5x35 mm / Cortical bone pin Ø1,5x35 mm.	4
Clé en T pour fiche / T-wrench for pin.	1
Clé en L Hex.3 / L-wrench Hex.3.	1

207011 Kit pour mini fixateur droit standard Standard lengthener mini fixator kit

Description	Qté.
Mini fixateur droit standard / Standard lengthener mini fixator.	1
Fiche à os cortical Ø1,5x35 mm / Cortical bone pin Ø1,5x35 mm.	4
Clé en T pour fiche / T-wrench for pin.	1
Clé en L Hex.3 / L-wrench Hex.3.	1

207012 Kit pour mini fixateur droit long Long lengthener mini fixator kit

Description	Qté.
Mini fixateur droit long / Long lengthener mini fixator.	1
Fiche à os cortical Ø1,5x35 mm / Cortical bone pin Ø1,5x35 mm.	4
Clé en T pour fiche / T-wrench for pin.	1
Clé en L Hex.3 / L-wrench Hex.3.	1

207020 Kit pour mini fixateur articulé à rail à axe horizontal (type 1)
Articulated mini rail fixator kit to horizontal axis (type 1)

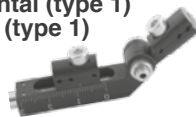

Description	Qté.
Mini fixateur articulé à rail à axe horizontal / Articulated mini rail fixator to horizontal axis.	1
Fiche à os cortical Ø1,5x35 mm / Cortical bone pin Ø1,5x35 mm.	4
Clé en T pour fiche / T-wrench for pin.	1
Clé en L Hex.3 / L-wrench Hex.3.	1

207021 Kit pour mini fixateur articulé à rail à axe vertical (type 2)
Articulated mini rail fixator to vertical axis kit (type 2)



Description	Qté.
Mini fixateur articulé à rail à axe vertical / Articulated mini rail fixator to vertical axis.	1
Fiche à os cortical Ø1,5x35 mm / Cortical bone pin Ø1,5x35 mm.	4
Clé en T pour fiche / T-wrench for pin.	1
Clé en L Hex.3 / L-wrench Hex.3.	1

207030 Kit pour mini fixateur droit à rail court
Short mini rail lengthener kit



Description	Qté.
Mini fixateur droit à rail court / Short mini rail lengthener.	1
Fiche à os cortical Ø1,5x35 mm / Cortical bone pin Ø1,5x35 mm.	4
Clé en T pour fiche / T-wrench for pin.	1
Clé en L Hex.3 / L-wrench Hex.3.	1

3 FIXATEURS EXTERNES LATERAL SOFIX
SOFIX LATERAL EXTERNAL FIXATORS

207031 Kit pour mini fixateur droit standard à rail
Standard mini rail lengthener kit



Description	Qté.
Mini fixateur droit standard à rail / Standard mini rail lengthener.	1
Fiche à os cortical Ø1,5x35 mm / Cortical bone pin Ø1,5x35 mm.	4
Clé en T pour fiche / T-wrench for pin.	1
Clé en L Hex.3 / L-wrench Hex.3.	1

207032 Kit pour mini fixateur droit à rail long
Long mini rail lengthener kit



Description	Qté.
Mini fixateur droit à rail long / Long mini rail lengthener.	1
Fiche à os cortical Ø1,5x35 mm / Cortical bone pin Ø1,5x35 mm.	4
Clé en T pour fiche / T-wrench for pin.	1
Clé en L Hex.3 / L-wrench Hex.3.	1

207040 Kit pour fixateur dynamique du poignet (Type1)
Pennig dynamic wrist fixator kit (Type1)

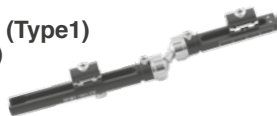

Description	Qté.
Fixateur dynamique de poignet type 1 / Pennig dynamic wrist fixator type 1.	1
Fiche à os cortical Ø1,5x35 mm / Cortical bone pin Ø1,5x35 mm.	4
Clé en T pour fiche / T-wrench for pin.	1
Clé en L Hex.3 / L-wrench Hex.3.	1

3 FIXATEURS EXTERNES LATERAL SOFIX
SOFIX LATERAL EXTERNAL FIXATORS

207041 Kit pour fixateur dynamique de poignet (Type2)
Pennig dynamic wrist fixator kit (Type2)



Description	Qté.
Fixateur dynamique de poignet type 2 / Pennig dynamic wrist fixator type 2.	1
Fiche à os cortical Ø1,5x35 mm / Cortical bone pin Ø1,5x35 mm.	4
Clé en T pour fiche / T-wrench for pin.	1
Clé en L Hex.3 / L-wrench Hex.3.	1
Support porte fiche unique / Single pin fixation support.	1

207042 Kit pour fixateur dynamique du poignet (Pour fracture extra articulaire et ostéotomie de correction)
Pennig dynamic wrist fixator kit (For extra-articular fracture and corrective osteotomies)



Description	Qté.
Fixateur dynamique de poignet / Pennig dynamic wrist fixator.	1
Fiche à os cortical Ø1,5x35 mm / Cortical bone pin Ø1,5x35 mm.	4
Clé en T pour fiche / T-wrench for pin.	1
Clé en L Hex.3 / L-wrench Hex.3.	1

207043 Kit pour fixateur articulé de poignet
Articulated wrist fixator kit



Description	Qté.
Fixateur articulé de poignet / Articulated wrist fixator.	1
Fiche à os cortical Ø1,5x35 mm / Cortical bone pin Ø1,5x35 mm.	4
Clé en T pour fiche / T-wrench for pin.	1
Clé en L Hex.3 / L-wrench Hex.3.	1

N3
061

3 FIXATEURS EXTERNES LATERAL SOFIX
SOFIX LATERAL EXTERNAL FIXATORS

207044 Kit pour fixateur radio transparent de poignet
Radiolucent wrist fixator system kit



Description	Qté.
Fixateur radio transparent de poignet / Radiolucent wrist fixator system.	1
Fiche à os cortical Ø3,3-Ø3,0 tige Ø4x80x25 mm / Cortical bone pin Ø3,3 Ø3,0 rod Ø4x80x25 mm.	2
Fiche à os cortical Ø3,3-Ø3,0 tige Ø4x70x20 mm / Cortical bone pin Ø3,3 Ø3,0 rod Ø4x70x20 mm.	2
Clé en T pour fiche Ø3 mm / T-wrench for pin Ø3 mm.	1
Clé en L Hex.4 / L-wrench Hex.4.	1

207050 Kit pour fixateur pour avant bras
Forearm fixator kit



Description	Qté.
Fixateur pour l'avant bras / Forearm fixator.	1
Fiche à os cortical Ø4x80 mm / Cortical bone pin Ø4x80 mm.	4
Clé en T pour fiche Ø4 mm / T-wrench for pin Ø4 mm.	1
Clé en L Hex.3 / L-wrench Hex 3.	1

207060 Kit pour fixateur pour le coude
Elbow fixator kit



Description	Qté.
Fixateur pour le coude / Elbow fixator.	1
Fiche à os cortical Ø6x180x50 mm / Cortical bone pin Ø6x180x50 mm.	4
Clé en T pour fiche à tige Ø6 mm / T-wrench for pin Ø6 mm.	1
Clé en L Hex.6 / L-wrench Hex.6.	1

3 FIXATEURS EXTERNES LATERAL SOFIX
SOFIX LATERAL EXTERNAL FIXATORS

207070 Kit pour fixateur de reconstruction court de membre pour adulte
Short limb reconstruction system kit for adult



Description	Qté.
Fixateur de reconstruction court de membre pour adulte / Short limb reconstruction system for adult.	1
Fiche à os cortical Ø6x50 mm / Cortical bone pin Ø6x50 mm.	4
Clé en T pour fiche Ø6 mm / T-wrench Ø6 mm.	1
Clé en L Hex.6 / L-wrench Hex.6.	1

207071 Kit pour fixateur de reconstruction standard de membre pour adulte
Standard limb reconstruction system kit for adult



Description	Qté.
Fixateur de reconstruction standard de membre pour adulte. Standard limb reconstruction system for adult.	1
Fiche à os cortical Ø6x50 mm. / Cortical bone pin Ø6x50 mm.	6
Clé en T pour fiche Ø6 mm. / T-wrench for pin Ø6 mm.	1
Clé en L Hex.6 / L-wrench Hex.6.	1

207072 Kit pour fixateur de reconstruction long de membre pour adulte
Long limb reconstruction system kit for adult



Description	Qté.
Fixateur de reconstruction long de membre pour adulte / Long limb reconstruction system for adult.	1
Fiche à os cortical Ø6x50 mm / Cortical bone pin Ø6x50 mm.	6
Clé en T pour fiche Ø6 mm / T-wrench for pin Ø6 mm.	1
Clé en L Hex.6 / L-wrench Hex.6.	1

3 FIXATEURS EXTERNES LATERAL SOFIX
SOFIX LATERAL EXTERNAL FIXATORS

207080 Kit pour fixateur dynamique axial court
Short dynamic axial fixator kit



Description	Qté.
Fixateur dynamique axial court pour fiche Ø6 mm / Short dynamic axial fixator for pin Ø6 mm.	1
Fiche à os cortical Ø6x50 mm / Cortical bone pin Ø6x50 mm.	6
Clé en T pour fiche Ø6 mm / T-wrench for pin Ø6 mm.	1
Clé en L Hex. 6 / L-wrench Hex.6.	1

207081 Kit pour fixateur dynamique axial standard
Standard dynamic axial fixator kit



Description	Qté.
Fixateur dynamique axial standard pour fiche Ø6 mm / Standard dynamic axial fixator for pin Ø6 mm.	1
Fiche à os cortical Ø6x50 mm / Cortical bone pin Ø6x50 mm.	4
Clé en T pour fiche Ø6 mm / T-wrench for pin Ø6 mm.	1
Clé en L Hex. 6 / L-wrench Hex.6.	1

207082 Kit pour fixateur dynamique axial court
Short dynamic axial fixator kit



Description	Qté.
Fixateur dynamique axial court pour fiche Ø5 mm / Short dynamic axial fixator for pin Ø5 mm.	1
Fiche à os cortical Ø5x150 avec filetage conique / Cortical bone pin Ø5x150 with conical thread.	4
Clé en T pour fiche Ø5 mm. / T-wrench for pin Ø5 mm.	1
Clé en L Hex. 5 / L-wrench Hex.5.	1

207083 Kit pour fixateur dynamique axial standard
Standard dynamic axial fixator kit



Description	Qté.
Fixateur dynamique axial standard pour fiche Ø5 mm / Standard dynamic axial fixator for pin Ø5 mm.	1
Fiche à os cortical Ø5x150 avec filetage conique / Cortical bone pin Ø5x150 with conical thread.	4
Clé en T pour fiche Ø5 mm / T-wrench for pin Ø5 mm.	1
Clé en L Hex. 5 / L-wrench Hex.5.	1

207084 Kit pour fixateur dynamique axial standard
Standard dynamic axial fixator kit



Description	Qté.
Fixateur dynamique axial standard pour fiche Ø4 mm / Standard dynamic axial fixator for pin Ø4 mm.	1
Fiche à os cortical Ø3,3-3,0 tige Ø4 auto perforante long.80 mm / Self drilling cortical bone pin Ø3,3-3,0 rod Ø4 length 80 mm.	4
Clé en T pour fiche Ø4 mm / T-wrench for pin Ø4 mm.	1
Clé en L Hex. 4 / L-wrench Hex.4.	1

3 FIXATEURS EXTERNES LATERAL SOFIX
SOFIX LATERAL EXTERNAL FIXATORS

207090 Kit pour fixateur en T dynamic axial court
Short dynamic axial T-fixator kit



Description	Qté.
Fixateur dynamique en T axial court pour fiche Ø6 mm / Short dynamic axial T-fixator for pin Ø6 mm.	1
Fiche à os cortical Ø6x180 mm à filetage conique / Cortical bone pin Ø6x180 mm with conical thread.	4
Clé en T pour fiche Ø6 mm / T-wrench for pin Ø6 mm.	1
Clé en L Hex. 6 / L-wrench Hex.6.	1

207091 Kit pour fixateur en T dynamic axial, standard
Standard dynamic axial T-fixator kit



Description	Qté.
Fixateur en T dynamique axial, standard, pour fiche Ø6 mm / Standard dynamic axial T-fixator for pin Ø6 mm.	1
Fiche à os cortical Ø6x180 mm à filetage conique / Cortical bone pin Ø6x180 mm with conical thread.	4
Clé en T pour fiche Ø6 mm / T-wrench for pin Ø6 mm.	1
Clé en L Hex. 6 / L-wrench Hex. 6.	1

207092 Kit pour fixateur en T dynamic axial, court
Short dynamic axial T-fixator kit



Description	Qté.
Fixateur en T dynamique axial, court, pour fiche Ø5 mm / Short dynamic axial T-fixator for pin Ø5 mm.	1
Fiche à os cortical Ø5x150 mm à filetage conique / Cortical bone pin Ø5x150 mm with conical thread.	4
Clé en T pour fiche Ø5 mm / T-wrench for pin Ø5 mm.	1
Clé en L Hex. 5 / L-wrench Hex. 5.	1

3 FIXATEURS EXTERNES LATERAL SOFIX
SOFIX LATERAL EXTERNAL FIXATORS

207093 Kit pour fixateur en T dynamic axial, standard
Standard dynamic axial T-fixator kit



Description	Qté.
Fixateur en T dynamique axial, standard, pour fiche Ø5 mm / Standard dynamic axial T-fixator for pin Ø5 mm.	1
Fiche à os cortical Ø5x150 mm à filetage conique / Cortical bone pin Ø5x150 mm with conical thread.	4
Clé en T pour fiche Ø5 mm / T-wrench for pin Ø5 mm.	1
Clé en L Hex. 5 / L-wrench Hex. 5.	1

207094 Kit pour fixateur en T dynamic axial standard
Standard dynamic axial T-fixator kit



Description	Qté.
Fixateur en T dynamique axial, standard, pour fiche Ø4 mm / Standard dynamic axial T-fixator for pin Ø4 mm.	1
Fiche à os cortical Ø4x35x80 mm / Cortical bone pin Ø4x35x80 mm.	4
Clé en T pour fiche Ø4 mm / T-wrench for pin Ø4 mm.	1
Clé en L Hex. 4 / L-wrench Hex.4.	1

3 FIXATEURS EXTERNES LATERAL SOFIX
SOFIX LATERAL EXTERNAL FIXATORS

207100 Kit pour fixateur pertrochanterien
Petrochanteric fixator kit

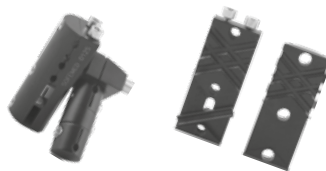

Description	Qté.
Fixateur pertrochanterienne / Petrochanteric fixator.	1
Fiche à os cortical Ø6x180 avec filetage conique long.50 mm / Cortical bone pin Ø6x180 with conical thread length 50 mm.	4
Clé en T pour fiche Ø6 mm / T-wrench for pin Ø6 mm.	1
Clé en L Hex. 5 / L-wrench Hex. 5.	1

207110 Kit pour fixateur en T court pour le bassin
Pelvic T-short fixator kit



Description	Qté.
Fixateur en T court pour le bassin / Pelvic T-short fixator.	1
Fiche à os cortical Ø6x180 avec filetage conique long.50 mm / Cortical bone pin Ø6x180 with conical thread length 50 mm.	6
Clé en T pour fiche Ø6 mm / T-wrench for pin Ø6 mm.	1
Clé en L Hex. 6 / L-wrench Hex. 6.	1

**207111 Kit pour fixateur long type 1 pour le bassin
Pelvic long fixator type 1**



Description	Qté.
Fixateur long type 1 pour le bassin / Pelvic long fixator type 1.	1
Fiche à os cortical Ø6x180 avec filetage conique long.50 mm / Cortical bone pin Ø6x180 with conical thread length 50 mm.	4
Clé en T pour fiche Ø6 mm / T-wrench for pin Ø6 mm.	1
Clé en L Hex. 6 / L-wrench Hex. 6.	1

**207112 Kit pour fixateur long type 2 pour le bassin
Pelvic long fixator type 2**



Description	Qté.
Fixateur long type 2 pour le bassin / Pelvic long fixator type 2.	1
Fiche à os cortical Ø6x180 avec filetage conique long.50 mm / Cortical bone pin Ø6x180 with conical thread length 50 mm.	4
Clé en T pour fiche Ø6 mm / T-wrench for pin Ø6 mm.	1
Clé en L Hex. 6 / L-wrench Hex. 6.	1

207120 Fixateur pour Tibia radiotransparent 1
Radiolucent Tibia fixator 1



Code	Description	Qté.
20712000	Fixateur pour tibia radio transparent 1. Radiolucent tibial fixator 1.	1
20712001	2/3 anneau Ø170 mm. 2/3 ring Ø170 mm.	1
20712002	Articulation pour tige Ø6 mm. Rod Ø6/Ø6 coupling.	4
20712003	Etau porte broche. Wire clamp.	2
307403	Fiches à cortical Ø6x180 mm. Cortical pin Ø6x180 mm.	4
201205-6	Barre d'union droite Ø6x300 mm. Straight rod Ø6x300 mm.	1
301068-350	Broche M/T Ø2,0x350 mm. M/T wire Ø2,0x350 mm.	2
20712004	Axe de maintien. Holding pin.	1
20712005	Boulon à tige Ø6 mm. Rod blot Ø6 mm.	1
507121	Clé en T pour fiche. T wrench for pin.	1
507122	Clé hexagonal en L double. Double hexagonal L-wrench.	1
502535	Clé en L. Hex. 6. L wrench Hex. 6.	1
502002	Clé mixte Hex. 10. Combination wrench Hex.10.	1

207122 Fixateur pour TIBIA radiotransparent 2
Radiolucent TIBIA fixator 2

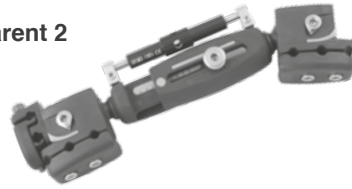

.Réf	Description	Qté.
20712200	Fixateur pour tibia radio transparent 2. Radiolucent tibia fixator 2.	1
307403	Fiches à cortical Ø6x180 mm. Cortical pin Ø6x180 mm.	4
207120-3	Articulation pour tige Ø6 mm. Rod Ø6 mm coupling.	2
201202-6	Barre d'union droite Ø6x300 mm. Straight rod Ø6x150 mm.	1
502535	Clé en L Hex. 6. L wrench Hex. 6.	1
507121	Clé en T pour fiche. T wrench for pin.	1
507122	Clé hexagonal en L double. Double hexagonal L-wrench.	1

207121 Fixateur pour cheville radiotransparent
Radiolucent ankle fixator



Code	Description	Qté.
20712100	Fixateur pour cheville radio transparent. Radiolucent ankle fixator.	1
307403	Fiche à os cortical Ø6x180x50 mm. Cortical bone pin Ø6x180x50 mm.	4
507121	Clé pour fiche Ø6 mm. Wrench for pin Ø6 mm.	1
507122	Clé hexagonal en L double. Double hexagonal L-wrench.	1

4 FIXATEURS EXTERNES CIRCULAIRES TYPE ILIZAROV
CIRCULAR EXTERNAL FIXATORS ILIZAROV TYPE

**Anneau
Full ring**



Ø Int. (mm)	Code SS
90	202001
100	202002
110	202003
120	202004
130	202005
140	202006
150	202007
160	202008
170	202009
180	202010
190	202011
200	202012
220	202014

N4
071

4 FIXATEURS EXTERNES CIRCULAIRES TYPE ILIZAROV
CIRCULAR EXTERNAL FIXATORS ILIZAROV TYPE

**Demi anneau
Half ring**



Ø Int. (mm)	Code SS
90	202021
100	202022
110	202023
120	202024
130	202025
140	202026
150	202027
160	202028
170	202029
180	202030
190	202031
200	202032
220	202034

4 FIXATEURS EXTERNES CIRCULAIRES TYPE ILIZAROV
CIRCULAR EXTERNAL FIXATORS ILIZAROV TYPE

**Boulon M6
Bolt M6**



Longueur/Length (mm)	Code SS
10	202101
16	202102
30	202103

**Ecrou M6
Nut M6**



Epaisseur / Thickness (mm)	Code SS
3	202112
4,8	202113
6	202111

**Ecrou frein
Stop nut**



Taille / Size	Code SS
M6	202119

**Ecrou carré gradué
Quadragonal nut**



Taille / Size	Code SS
M6	202341

N4
073

4 FIXATEURS EXTERNES CIRCULAIRES TYPE ILIZAROV
CIRCULAR EXTERNAL FIXATORS ILIZAROV TYPE

Plaque de liaison longue
Long connection plate



Trous / Holes	Longueur/Length (mm)	Code SS
8	155	202201
12	235	202202
17	335	202203

Plaque de liaison courte
Short connection plate

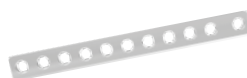

Trous / Holes	Longueur/Length (mm)	Code SS
2	35	202211
4	55	202212
6	75	202213
8	95	202214
10	115	202215

Plaque de liaison à bout fileté
Connection plate with threaded end



Trous / Holes	Longueur/Length (mm)	Code SS
5	135	202222
7	175	202223
9	215	202224
11	255	202225

Plaque vrillée
Twisted plate



Trous / Holes	Longueur/Length (mm)	Code SS
2	45	202231
3	65	202232
4	85	202233

4 FIXATEURS EXTERNES CIRCULAIRES TYPE ILIZAROV
CIRCULAR EXTERNAL FIXATORS ILIZAROV TYPE

Tige filetée M6
Threaded rod M6



Longueur/Length (mm)	Code SS	Longueur/Length (mm)	Code SS
60	202301	250	202307
80	202302	300	202308
100	202303	350	202309
120	202304	400	202310
150	202305	500	202311
200	202306	600	202312

Tige filetée avec fente
Slotted threaded rod



Longueur/Length (mm)	Code SS
40	202321
60	202322
80	202323
100	202324
120	202325

Tige filetée avec trou
Cannulated threaded rod



Longueur/Length (mm)	Code SS
40	202331
60	202332
80	202333
100	202334
120	202335

N4
075

4 FIXATEURS EXTERNES CIRCULAIRES TYPE ILIZAROV
CIRCULAR EXTERNAL FIXATORS ILIZAROV TYPE

Tige télescopique
Telescopic rod



Longueur/Length (mm)	Code
100	202351
150	202352
200	202353

Bloc
Cubes



Trous / Holes	Code SS
1	202120
2	202121
3	202122
4	202123
5	202124

202401 Charnière male
Hinge male



202402 Charnière femelle
Hinge femorale



202241 Plaque courbe
Curved plate



202511 Manchon fileté rond
Bushing



4 FIXATEURS EXTERNES CIRCULAIRES TYPE ILIZAROV
CIRCULAR EXTERNAL FIXATORS ILIZAROV TYPE

202531 Paire de rondelles coniques
Pair conical washer



202541 Rondelle avec fente
Slotted washer



202551 Rondelle à crans
Star washer



202601 Boulon avec trou
Cannulated bolt



202611 Boulon de serrage avec fente
Slotted bolt



202621 Boulon avec trou et tête filetée femelle
Cannulated bolt with threaded head



N4
077

4 FIXATEURS EXTERNES CIRCULAIRES TYPE ILIZAROV
CIRCULAR EXTERNAL FIXATORS ILIZAROV TYPE

202631 Bride de serrage amovible
Wire fixation buckle



202721 Support oblique de connexion
Oblique support connection



202801 Porte-fiche unique
Single pin fixation clamp



202811 Porte-fiche multiple
Multiple pin fixation clamp



4 FIXATEURS EXTERNES CIRCULAIRES TYPE ILIZAROV
CIRCULAR EXTERNAL FIXATORS ILIZAROV TYPE

Drapeau fileté mâle
Post male



Trous / Holes	Longueur/Length (mm)	Code SS
2	48	202411
3	58	202412
4	68	202413

Drapeau fileté femelle
Post female



Trous / Holes	Longueur/Length (mm)	Code SS
2	34	202421
3	44	202422
4	54	202423

Manchon fileté hexagonal
Threaded socket



Longueur/Length (mm)	Code SS
20	202501
40	202502

4 FIXATEURS EXTERNES CIRCULAIRES TYPE ILIZAROV
CIRCULAR EXTERNAL FIXATORS ILIZAROV TYPE

**Rondelle plate
Spacing washer**



Epaisseur / Thickness (mm)	Code SS
1,5	202521
2,0	202522

**Barre de jonction mâle
Male connecting rod**



Longueur/Length (mm)	Code SS
80	202701
125	202702
170	202703
215	202704

**Barre de jonction femelle
Female connecting rod**



Longueur/Length (mm)	Code SS
70	202711

4 FIXATEURS EXTERNES CIRCULAIRES TYPE ILIZAROV
CIRCULAR EXTERNAL FIXATORS ILIZAROV TYPE

Arche fémoral
Femoral arche



Taille /Size	Angle	Code SS
Petite/Small	90°	202730
Petite/Small	120°	202731
Grande/Large	90°	202732
Grande/Large	120°	202733

4 FIXATEURS EXTERNES CIRCULAIRES TYPE ILIZAROV
CIRCULAR EXTERNAL FIXATORS ILIZAROV TYPE

Broche avec olive
Olive wire



Ø (mm)	Longueur/Length (mm)	Code SS
1,5	300	301011
1,8		301012
2,0		301013
1,5	400	301021
1,8		301022
2,0		301023

Broche de Kirschner 2 trocars
Kirschner wire 2 trocars



Ø (mm)	L (mm)	Code SS	Ø (mm)	L (mm)	Code SS
0,8	300	301041	2,0	300	301048
1,0		301042	2,2		301049
1,2		301043	2,4		301050
1,4		301044	2,5		301051
1,5		301045	2,6		301052
1,6		301046	2,8		301053
1,8		301047	3,0		301054

Fiches à os cortical Ø6-5 mm
Cortical bone pin Ø6-5 mm



Longueur/Length (mm)	Long. filetée / Threaded length (mm)	Code SS
120	50	307401
150		307402
180		307403
200		307404
220		307405
250		307406
300		307407

4 FIXATEURS EXTERNES CIRCULAIRES TYPE ILIZAROV
CIRCULAR EXTERNAL FIXATORS ILIZAROV TYPE

202901 Mini tendeur de broche.
Mini wire tensioner.



202911 Tendeur de broche.
Wire tensioner.



**1202813-
223-23** Pince coupe broche jusqu'à
Ø2,5 mm.
Wire cutting pliers up to
Ø2,5 mm.



101021 Mandrin universel avec
clé.
Universal chuck with key.



4 FIXATEURS EXTERNES CIRCULAIRES TYPE ILIZAROV
CIRCULAR EXTERNAL FIXATORS ILIZAROV TYPE

100002 Marteau 500g.
Hammer 500g.



502001 Clé en T Hex. 10.
T-wrench Hex. 10.



502002 Clé mixte Hex.10.
Combination wrench
Hex.10.



502003 Clé tubulaire Hex.10.
Tubular wrench Hex.10.



4 FIXATEURS EXTERNES CIRCULAIRES TYPE ILIZAROV
CIRCULAR EXTERNAL FIXATORS ILIZAROV TYPE

502005F Set de fixateur externe type ilizarov
External fixator set ilizarov type



Code	Description	Qté.
502005FB	Boite vide avec couvercle filtré. Sterile container systems.	01
502005FP1	Panier. / Rack	01
502005FP2	Panier. / Rack	01
502005FP3	Panier. / Rack	01
502005FP4	Panier. / Rack	01
202901	Mini tendeur de broche. Mini wire tensioner.	01
202911	Tendeur de broche. Wire tensioner.	01
100113	Pince coupe broche jusqu'à Ø2,5 mm. Wire cutting pliers up to Ø2,5 mm.	01
101022	Mandrin universel. Universal chuck.	01
100002	Marteau 500g. Hammer 500g.	01
502002	Clé mixte Hex.10. Combination wrench Hex.10.	01
502003	Clé tubulaire Hex.10 Tubular wrench Hex.10	02
502001	Clé en T Hex. 10. T-wrench Hex. 10.	02
202021	Demi anneau 90 mm. Half ring size 90 mm.	06
202022	Demi anneau 100 mm. Half ring size 100 mm.	06
202024	Demi anneau 120 mm. Half ring size 120 mm.	06
202351	Tige télescopique 100 mm. Telescopic rod 100 mm.	03
202212	Plaque de liaison courte 4 trous. Short connection plate, 4 holes.	04
202213	Plaque de liaison courte 6 trous. Short connection plate, 6 holes.	04

N4
085

4 FIXATEURS EXTERNES CIRCULAIRES TYPE ILIZAROV
CIRCULAR EXTERNAL FIXATORS ILIZAROV TYPE

Code	Description	Qté.
202501	Manchon fileté hexagonal long. 20 mm. Threaded socket length 20 mm.	02
202502	Manchon fileté hexagonal long. 40 mm. Threaded socket length 40 mm.	02
301022	Broche avec olive 1,8x400 mm. / Olive wire 1,8x400 mm.	02
202026	Demi anneau 140 mm. / Ilizarov half ring 140 mm.	08
202028	Demi anneau 160 mm / Ilizarov half ring 160 mm.	08
202352	Tige télescopique 150 mm. / Telescopic rod 150 mm.	03
202303	Tige filetée, 100 mm. / Threaded rod 100 mm.	06
202305	Tige filetée, 150 mm. / Threaded rod 150 mm.	06
202306	Tige filetée, 200 mm. / Threaded rod 200 mm.	06
202030	Demi anneau 180 mm. / Ilizarov half ring 180 mm.	08
202032	Demi anneau 200 mm. / Ilizarov half ring 200 mm.	08
202034	Demi anneau 220 mm. / Ilizarov half ring 220 mm.	08
202353	Tige télescopique 200 mm. / Telescopic rod 200 mm.	03
202307	Tige filetée M6, 250 mm. / Threaded rod M6 250 mm.	06

Kit pour Halo crânien / Halo cranial set



Anneau Halo Halo ring

Taille / Size (mm)	Code SS	Code Titane
1 (170x200)	203001	203001T
2 (180x210)	203002	203002T
3 (185x220)	203003	203003T
4 (190x230)	203004	203004T
5 (200x240)	203005	203005T

Support pour épaule Shoulder support



Taille / Size	Code SS	Code Titane
Grand / Large	203011	203011T
Petit / Small	203012	203012T

N5
087

5 SYSTEME DE TRACTION HALO
HALO TRACTION SYSTEM

Vis cranienne Ø 6mm
Skull pin Ø 6mm



Long. / Length (mm)	Code SS	Code Titane
56	203031	203031T
76	203032	203032T

203021 Plaque de blocage
Locking plate



102041 Etrier de Gardner
Gardner traction



Ridoir
Distractor



Taille / Size	Long. ouvert Opened length (mm)	Long. fermé Closed length (mm)	Code SS	Code Titane
Grand / Large	330	200	109911	109911T
Moyen / Medium	246	156	109912	109912T
Petit / Small	206	136	109913	109913T

204041 Mini fixateur®
Mini fixator



Broche à extrémité filetée / mousse
Wire end thread / round



Ø (mm)	Longueur/Length (mm)	Code SS
2,0	100	301213-100

504041 Clé en T
T-wrench

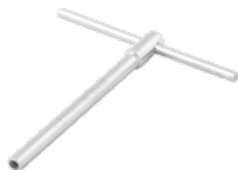

101002 Tournevis Hex.2,5
Screw driver Hex.2,5



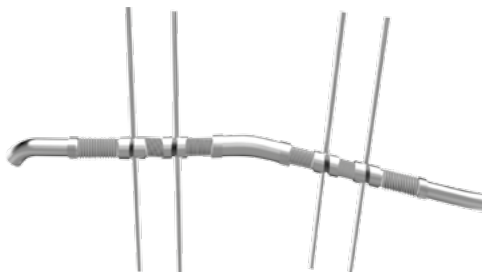

Tige filetée avec fente
Slotted threaded rod



Longueur/Length (mm)	Code SS
50	204001
60	204002
70	204003

Manchon de connexion
Connecting socket



Angle	Code SS
0°	204021
20°	204022
40°	204023

Broche de Kirschner pointe trocar
Kirschner wire trocar point



Ø (mm)	Longueur/Length (mm)	Code SS
1,5	100	301065-100

Ecrou hexagonal
Hexagonal nut



Taille / Size	Code SS
M6	202113